

ABB i-bus® EIB EIB Delta-Meter Electricity Meters

Intelligent Installation Systems



EIB Delta-Meter Electricity meters

General Description

The EIB Delta-Meters are a new generation of certified, digital electronic electricity meters with integrated ABB i-bus® EIB communication interface for the measurement of electrical energy consumption.

The EIB Delta-Meters are compact, highly reliable with substantial immunity to EM disturbances and are suitable for use in single and polyphase voltage networks. The meters have no mechanical moving parts and thus can be easily mounted in any orientation onto DIN rails according to EN 50022 or panel mounted using the panel mounting kit.

The EIB-communication interface allows remote reading of the meter data over ABB i-bus® EIB for billing, energy optimisation, visualisation or installation monitoring purposes. The EIB Delta-Meter can be universally employed for sub-metering applications in industrial installations, commercial buildings, offices complexes, leisure facilities or private housing.

Special Features

- Precise measurement of energy consumption (kWh, also kvarh with Combi-meters)
- For 2, 3 and 4 wire voltage networks with symmetric or asymmetric loading (50/60 Hz)
- Integrated EIB-bus connection for remote reading of meter data
- Network monitoring function: registration and display of up to 24 electrical measurement values
- Automatic control of the meter installation with „Installation self-test“
- PTB-approved
- Easy to read LCD-Display, LED-display for energy consumption
- Direct connection up to 65 A (Measurement range 0,05 A to 65 A)
- Transformer connection (/1A and /5A secondary) with transformer meter, also for $I_n > 65 A$
- Accuracy class 1 or 2
- Tariff meters with 4 tariffs
- Meters fulfil standards IEC 1036/1268
- System pro M Design with sealable housing for snap fixing on 35 mm DIN rails

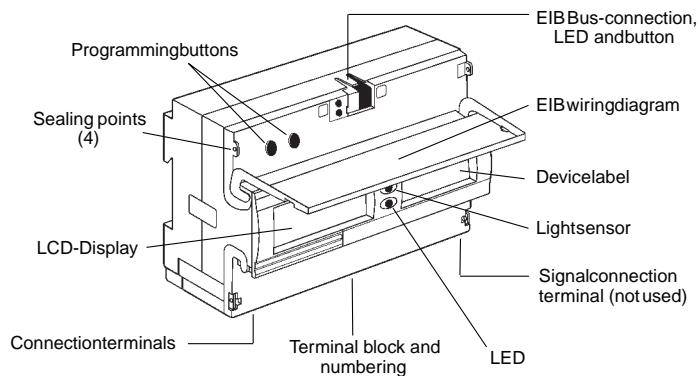

Dimensions (in mm)

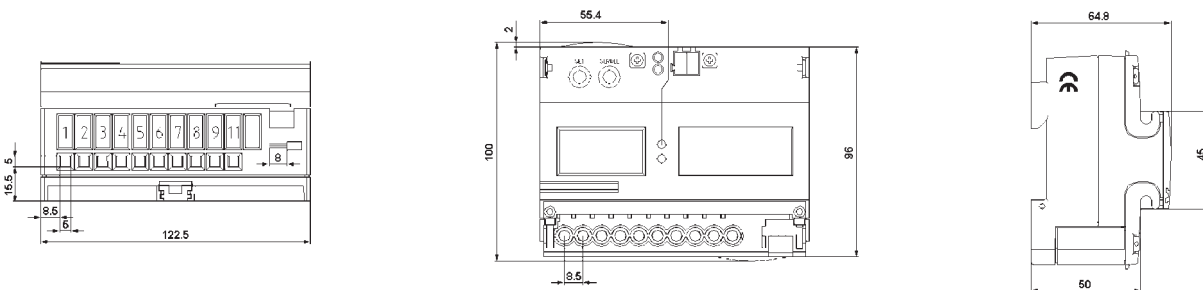

Panel mounting kit

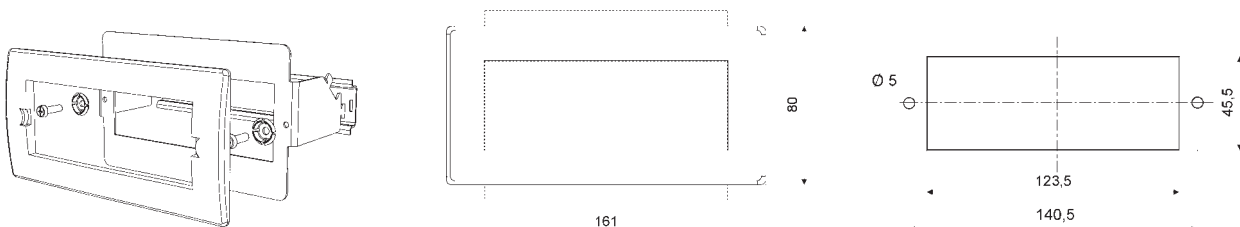

EIB Delta-Meter Electricity meters

Technical Data

Accuracy:	Active energy meters:	Class 1 and 2 according to IEC1036
	Reactive energy meters:	Class 2 according to IEC1268
Voltage:	Voltage (– 20% ... +15%):	see selection table
Rated current I_b (maximum current $I_{max})$:	Transformer rated meters: (/1 A or /5 A secondary)	1(6) A for class 1, 2(6) A for class 2
	Direct connected meters:	5(65) A for class 1 and 2
Starting current:	Transformer rated meters: (/1 A or /5 A secondary)	< 2 mA for class 1, < 4 mA for class 2
	Direct connected meters:	< 25 mA
Power consumption:	Voltage path:	< 2 VA, 1,5 W per phase
	Current path:	< 0.01 VA at $I_{b,Transformer} = 2$ A and at $I_{b,Direct} = 5$ A
Frequency:	Rated (Range):	50 Hz (45 Hz ... 65 Hz)
Electromagnetic compatibility (EMC):	Surge voltage:	6 kV, 1,2/50 μ s (IEC 255-4)
	Burst:	4 kV, 5/50 ns (IEC 801-4)
	Radio frequency immunity:	10 V/m, 150 kHz – 1 GHz (IEC 1000-4-3)
	Electrostatic discharge:	15 kV (IEC 801-2)
Circuit protection:	Transformer rated meters:	max. 6 A gl
	Direct connected meters:	max. 65 A gl (63 A)
Environmental conditions:	Operating temperature range:	– 5 °C ... + 45 °C
Mechanical data:	Dimensions (H x B x T):	96 x 122.5 x 64.8 mm
	Protection class	II
	Cable cross section: – Transformer rated meters – Direct connected meters	max. 10 mm ² max. 25 mm ²
Display:	LCD-display:	7 digits, height 7 mm
	LED-display: – Direct connected meters – Transformer rated meters	red LED, 1000 Imp/kWh (kvarh) red LED, 5000 Imp/kWh (kvarh)
EIB-connection:	Current supply:	via ABB i-bus [®] , EIB
	EMV: – Impulse voltage – Burst	6 kV, 1,2/50 μ s (IEC 255-4) 4 kV, 5/50 ns (IEC 801-4)
	Operating- and display elements: – ABB i-bus [®] – LED red and button	Bus connection terminal (included) for programming the physical address
Standards:	Meter	IEC 1036, IEC 1268, PTB-number 20.15 98.80

Connection Diagrams

Single phase

Direct connected meters

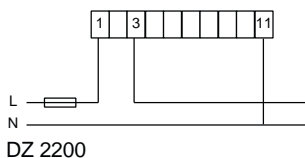

3-phase without neutral

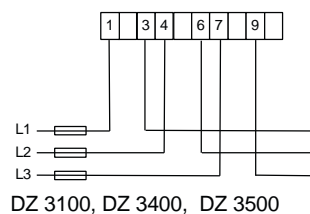

3-phase with neutral

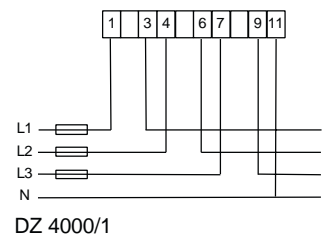

Transformer rated meters

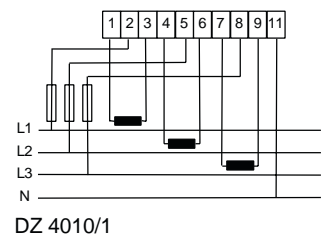
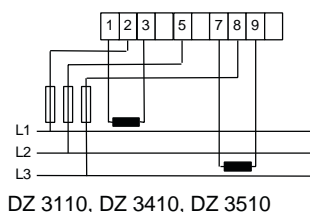
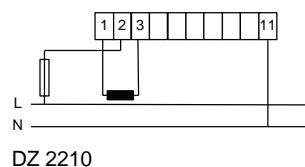

EIB Delta-Meter

Electricity meters

EIB Delta-Meter Program with network monitoring function

Voltage V	Current A	Class	Ordering info.		bbn 40 16779 EAN	Price 1 Pc.	Price groupe	Weight 1 Pc. (kg)	Pack. (Pc.)
			Short Code	Product Code					

Transformer rated meters for /1 A or /5 A current transformer

Active energy meters

1 x 230	2(6)	2	DZ 2210 W E	GH V782 2100 R0100	51128 5	26	0,6	1
3 x 110	2(6)	2	DZ 3110 W E	GH V783 1100 R0100	51129 2	26	0,6	1
3 x 400	2(6)	2	DZ 3410 W E	GH V783 4100 R0100	51130 8	26	0,6	1
3 x 500	2(6)	2	DZ 3510 W E	GH V783 5100 R0100	51131 5	26	0,6	1
3 x 230/400	1(6)	1	DZ 4011 W E	GH V784 0101 R0100	51132 2	26	0,6	1
3 x 230/400	2(6)	2	DZ 4010 W E	GH V784 0100 R0100	51133 9	26	0,6	1

Combi meters (active and reactive energy)

3 x 230/400	2(6)	2	DZ 4010 K E	GH V784 0100 R2100	51134 6	26	0,6	1
-------------	------	---	-------------	--------------------	---------	----	-----	---

Tariff meter (4 Tariff)

3 x 230/400	2(6)	2	DZ 4010 WT E	GH V784 0100 R0140	51135 3	26	0,6	1
-------------	------	---	--------------	--------------------	---------	----	-----	---

Direct connected meters

Active energy meters

1 x 230	5(65)	2	DZ 2200 W E	GH V782 2000 R0100	51143 8	26	0,6	1
3 x 400	5(65)	2	DZ 3400 W E	GH V783 4000 R0100	51144 5	26	0,6	1
3 x 230/400	5(65)	1	DZ 4001 W E	GH V784 0001 R0100	51145 2	26	0,6	1
3 x 230/400	5(65)	2	DZ 4000 W E	GH V784 0000 R0100	51146 9	26	0,6	1

Combi meters (active and reactive energy)

3 x 230/400	5(65)	2	DZ 4000 K E	GH V784 0000 R2100	51147 6	26	0,6	1
-------------	-------	---	-------------	--------------------	---------	----	-----	---

Tariff meter (4 Tariff)

3 x 230/400	5(65)	2	DZ 4000 WT E	GH V784 0000 R0140	51148 3	26	0,6	1
-------------	-------	---	--------------	--------------------	---------	----	-----	---

Accessories

Description	Ordering Info.		bbn 40 16779 EAN	Price 1 Pc.	Price groupe	Weight 1 Pc. [kg]	Pack. [Pc.]
	Short Code	Product Code					

Flush-mount kit for Delta-Meter	DZ-FTB	GH V780 0000 R0000	48120 5	16	0,21	1
---------------------------------	--------	--------------------	---------	----	------	---

Note: Transformer rated EIB Delta-Meters do not have a programmable transformer ratio. Therefore all displayed and transmitted measurement values are secondary values. The EIB Delta-Meters do not possess an S0 impulse output.



Your EIB-Partner